

EW170L - SASH WINDOW LEAD WEIGHTS & CORDS

Thermal Transmittance:
 $U_w = 1.093 \text{ W/m}^2\text{K}$;
 (1.23m x 1.48m opening standard size)

Airtightness:
 Class 4

Product
 EW170L
 SASH WINDOW
 LEAD WEIGHTS & CORDS

Drawing Title
 PERFORMANCE

Glazing Unit
 Triple Glazed

Scale	Date	Page
A4 - 1:14	2023.12	1



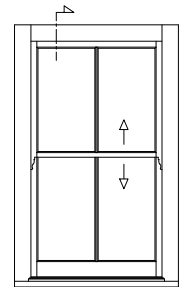
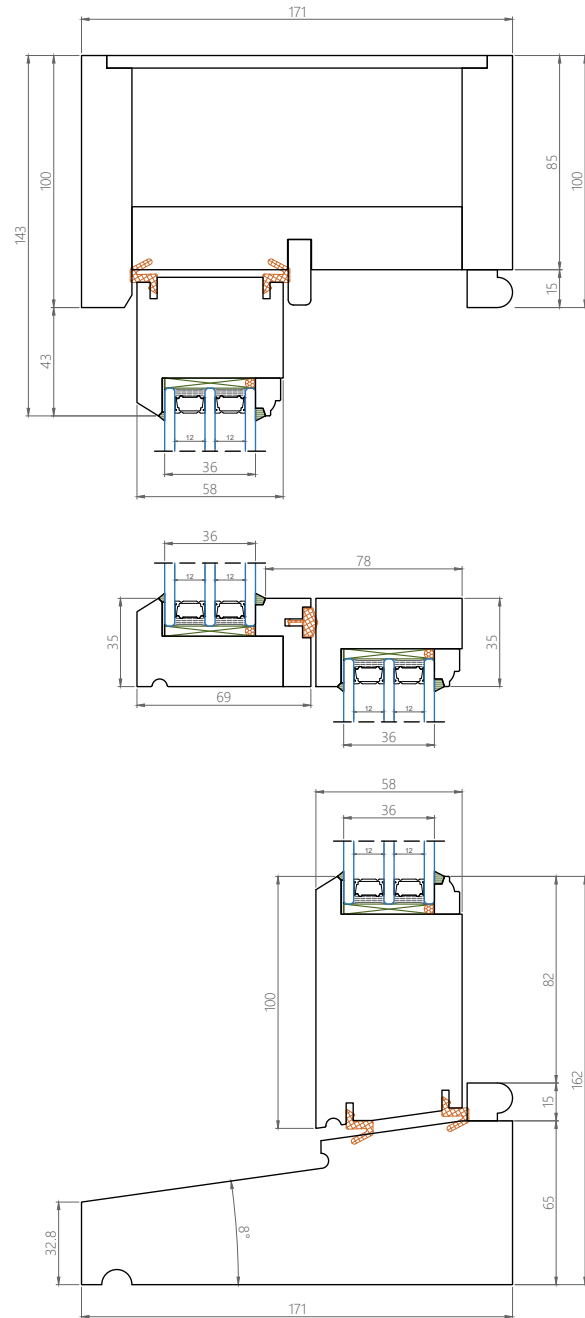

Product
 EW170L
 SASH WINDOW
 LEAD WEIGHTS & CORDS

Drawing Title
 VERTICAL CROSS
 SECTION

Glazing Unit
 Triple Glazed

Scale A4 - 1:3	Date 2023.12	Page 2
-------------------	-----------------	-----------



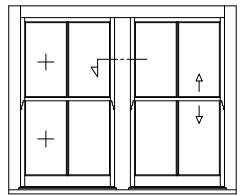
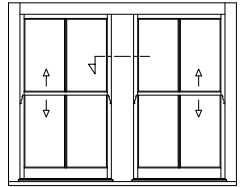
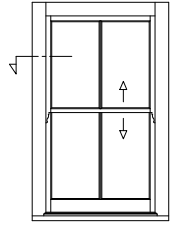
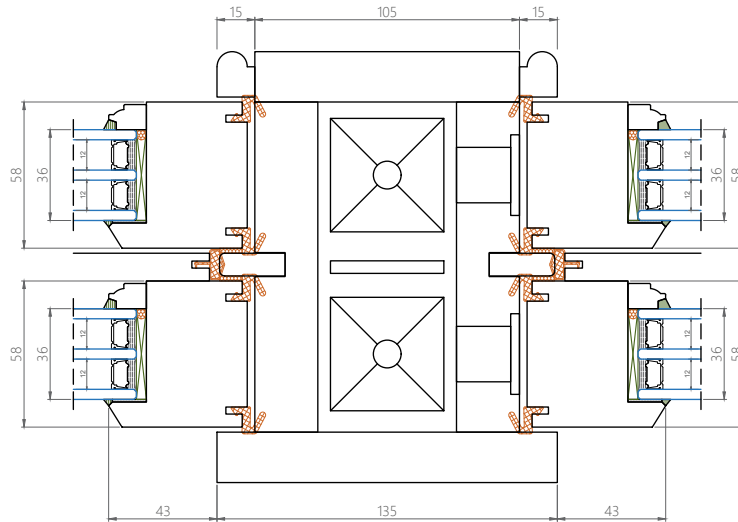
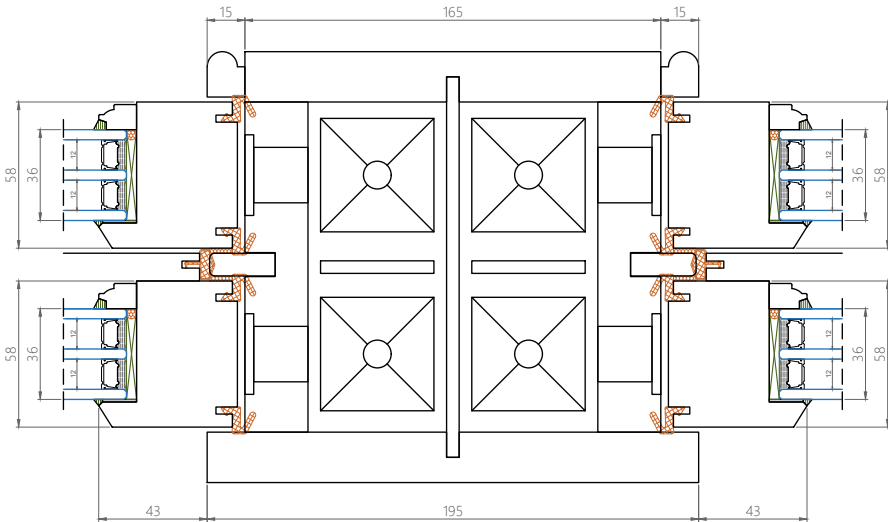
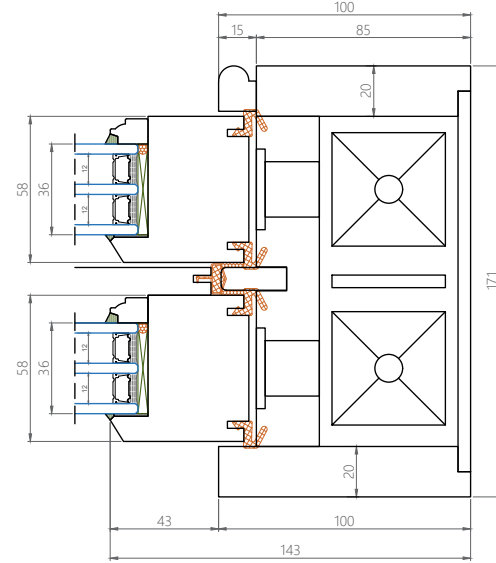
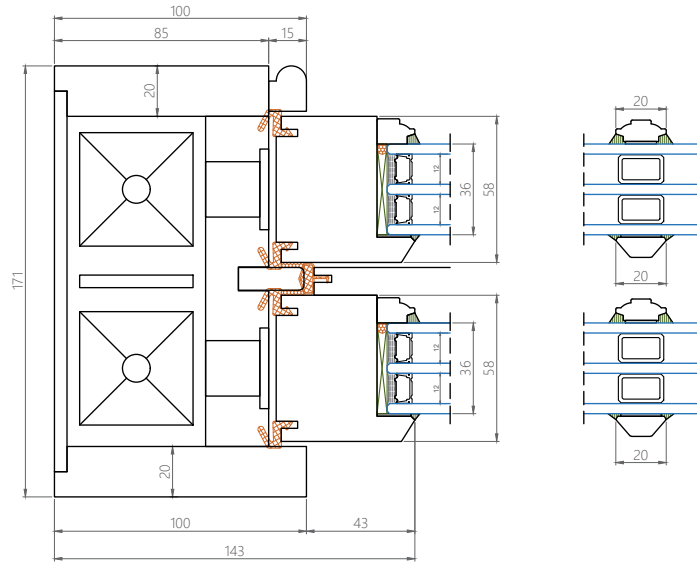

Product
 EW170L
 SASH WINDOW
 LEAD WEIGHTS & CORDS

Drawing Title
 HORIZONTAL
 CROSS SECTION

Glazing Unit
 Triple Glazed

Scale A4 - 1:3	Date 2023.12	Page 3
-------------------	-----------------	-----------



HORN H-1

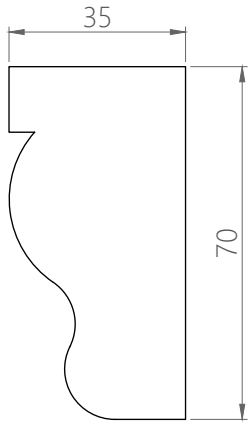

HORN H-2

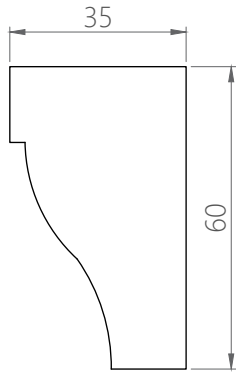

HORN H-3

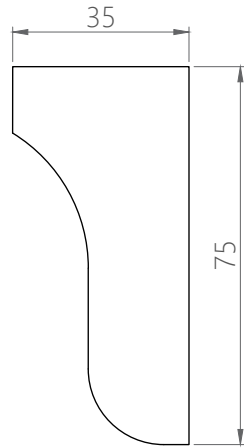

HORN H-4

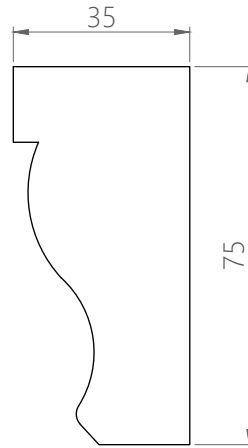

HORN H-5

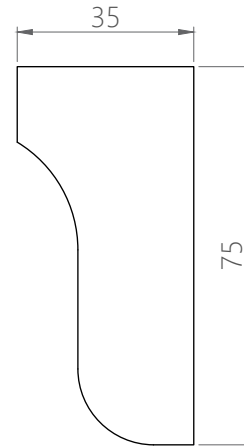

HORN H-6

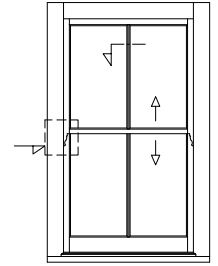
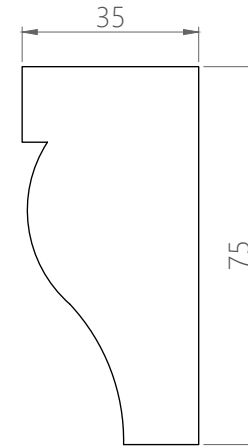

External

Internal

S13

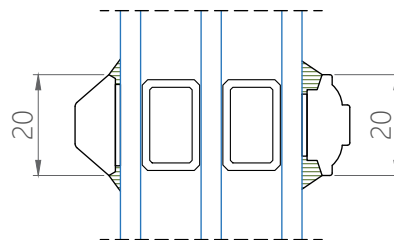

GT-01

Product
 EW170L
 SASH WINDOW
 LEAD WEIGHTS & CORDS

Drawing Title
 GLAZING BARS AND
 HORN OPTIONS

Glazing Unit
 Triple Glazed

Scale A4 - 1:1.5	Date 2023.12	Page 4
---------------------	-----------------	-----------



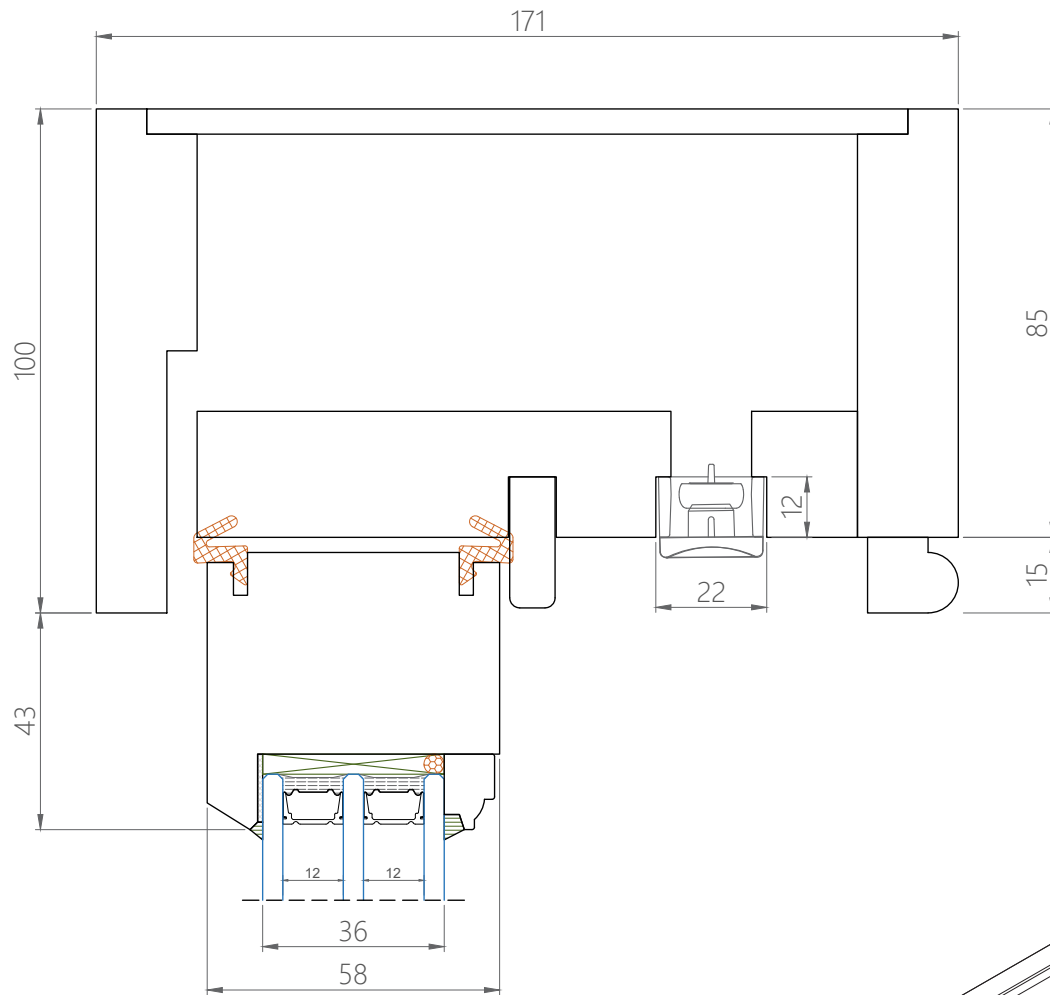

CLOSED OPTION

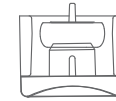

OPEN OPTION

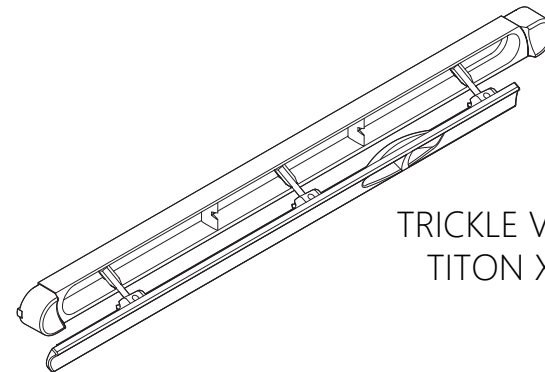
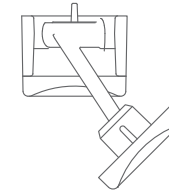

TRICKLE VENT -
TITON XR16

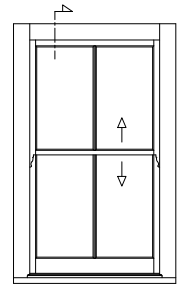

Product

EW170L
SASH WINDOW
LEAD WEIGHTS & CORDS

Drawing Title

TRICKLE VENT
CROSS SECTION

Glazing Unit

Triple Glazed

Scale

A4 - 1:1.5

Date

2023.12

Page

5