

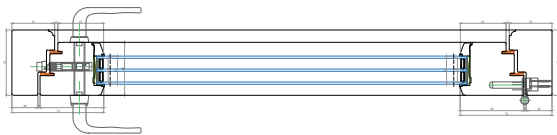

ED98T - TIMBER OUTWARD
OPENING DOOR

Thermal Transmittance:
 $U_w = 0,79 \text{ W/m}^2\text{K}$;
 (1000mm x 2100mm opening standard size)



Product	ED98T TIMBER INWARD OPENING DOOR		Glazing Unit		Triple Glazed	
	Scale	A4 - 1:14	Date	2024.06	Page	1
Drawing Title	PERFORMANCE					

ED98T - 1

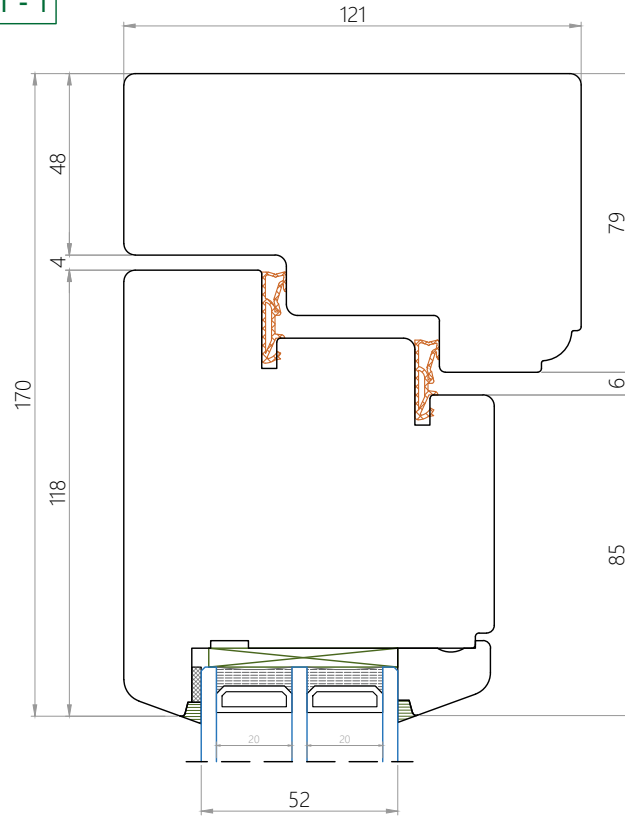

ED98T - 2

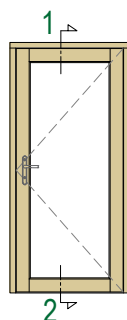
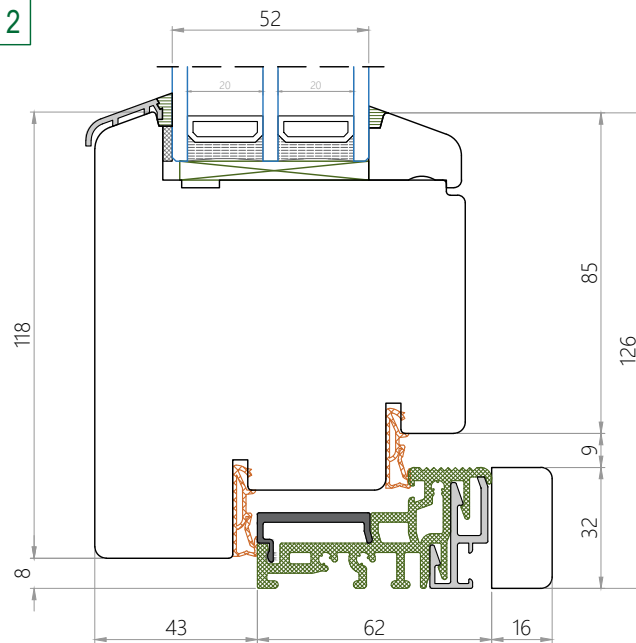

Product

ED98T
TIMBER OUTWARD
OPENING DOOR

Drawing Title

VERTICAL CROSS
SECTION

Glazing Unit

Triple Glazed

Scale

A4 - 1:2

Date

2024.06

Page

2



Eksalta
Windows
& Doors

ED98T - 5

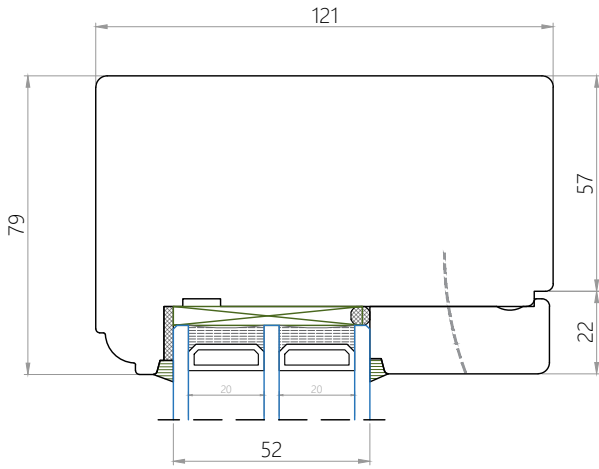

ED98T - 5

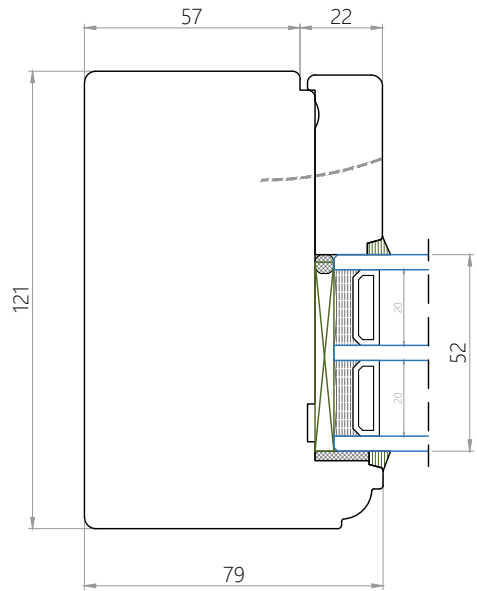

ED98T - 6

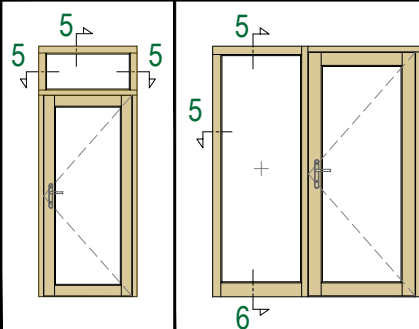
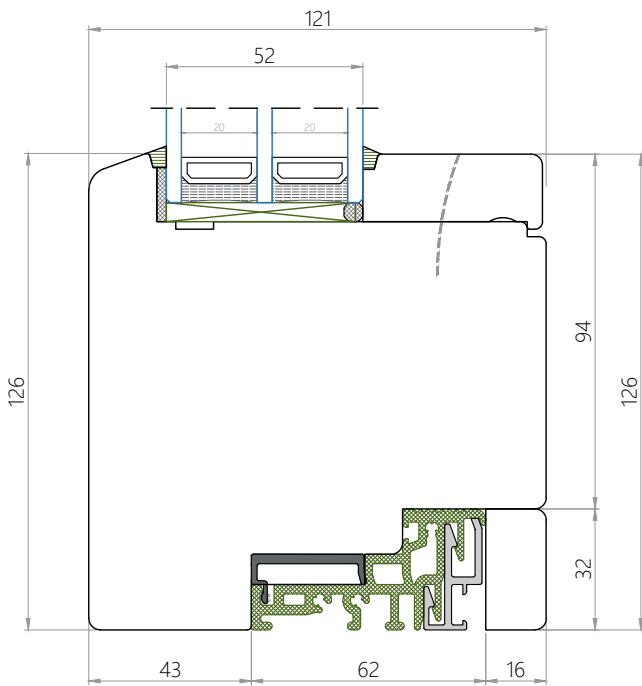

Product
ED98T
TIMBER OUTWARD
OPENING DOOR

Drawing Title
TOPLIGHT AND
SIDELIGHT SECTIONS

Glazing Unit
Triple Glazed

Scale A4 - 1:2	Date 2024.06	Page 4
-------------------	-----------------	-----------



ED98T - 7

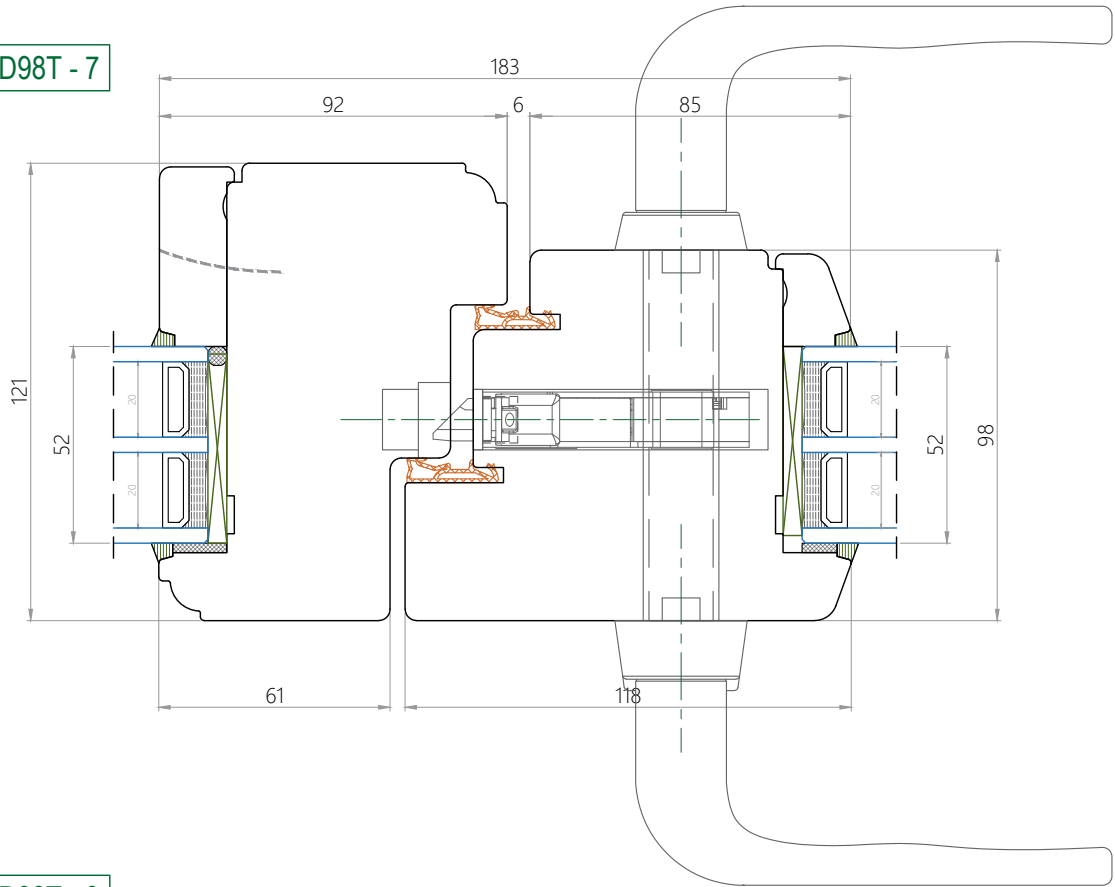

ED98T - 8

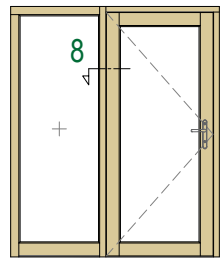
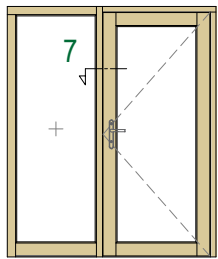
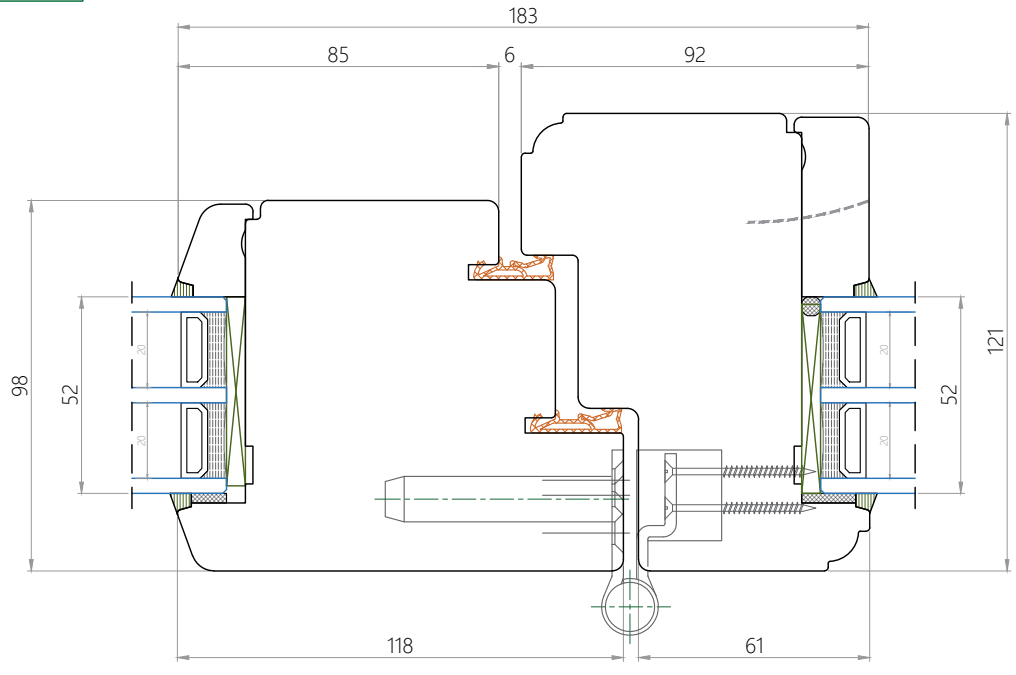

Product
ED98T
TIMBER OUTWARD
OPENING DOOR

Drawing Title
MULLION
SECTIONS

Glazing Unit
Triple Glazed

Scale A4 - 1:2	Date 2024.06	Page 5
-------------------	-----------------	-----------



ED98T - 9

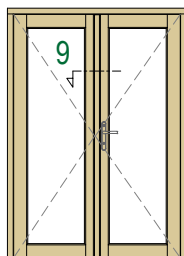
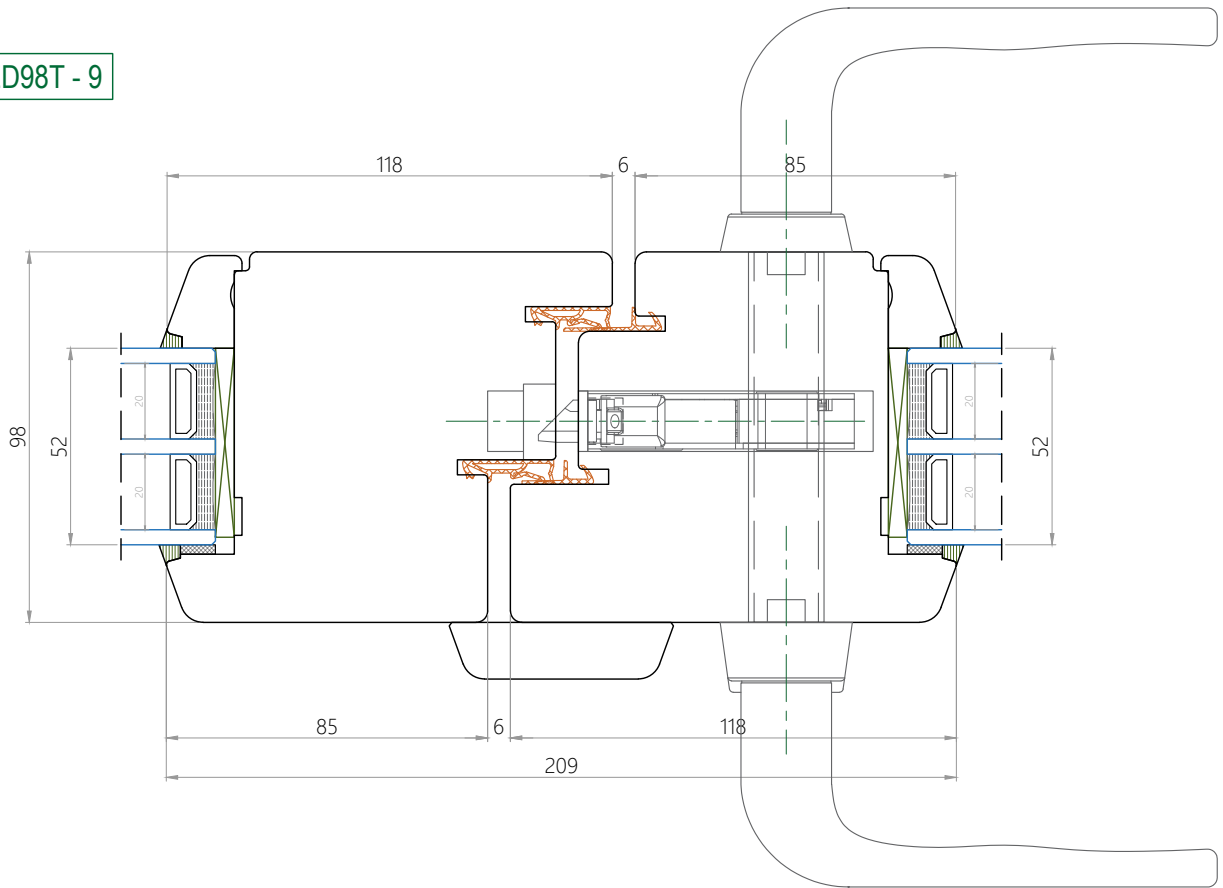

Product
ED98T
TIMBER OUTWARD
OPENING DOOR

Drawing Title
MULLION
SECTIONS

Glazing Unit
Triple Glazed

Scale A4 - 1:2	Date 2024.06	Page 6
-------------------	-----------------	-----------



ED98T - 10

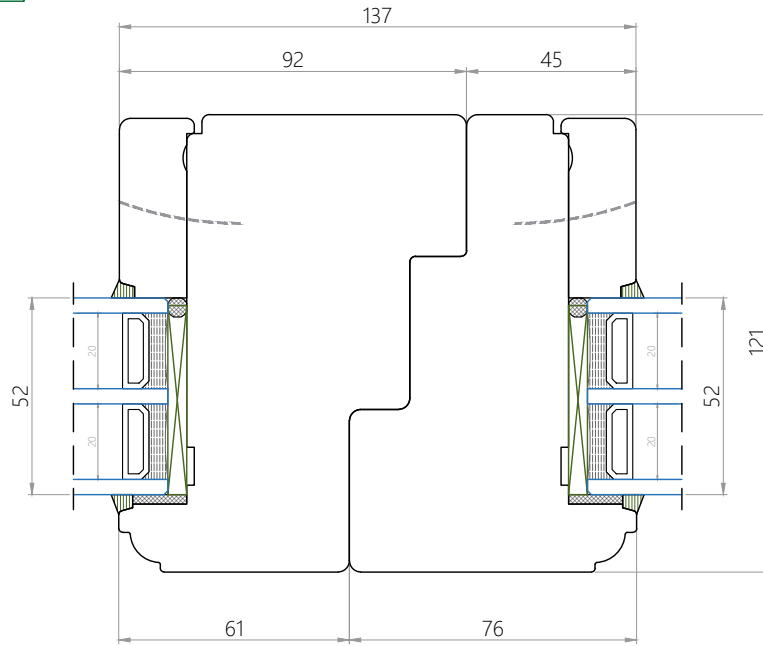

ED98T - 11

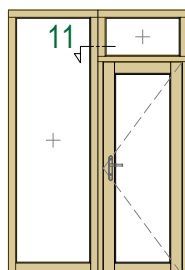
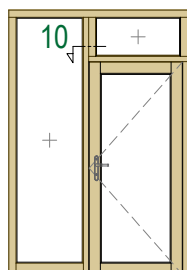
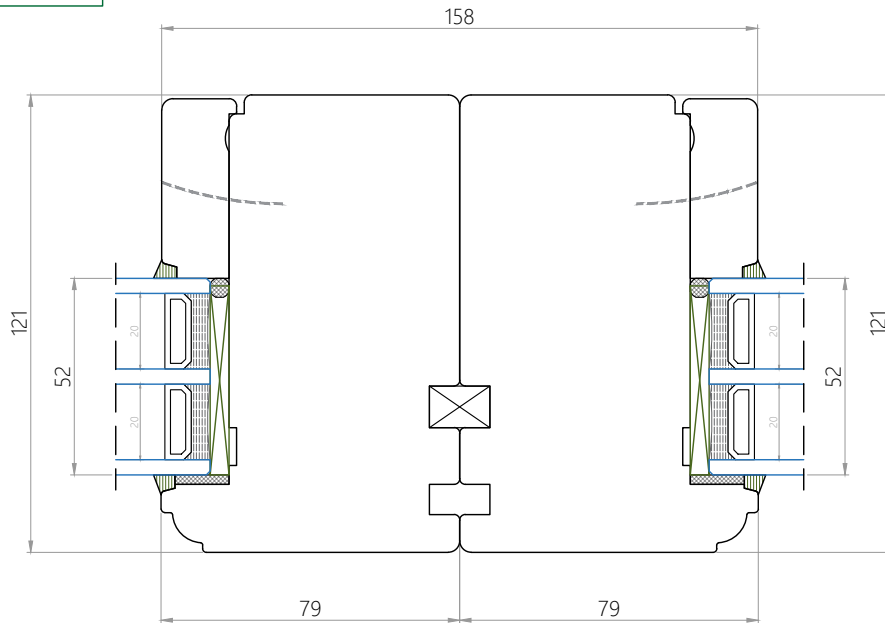

Product
ED98T
TIMBER OUTWARD
OPENING DOOR

Drawing Title
MULLION
SECTIONS

Glazing Unit
Triple Glazed

Scale
A4 - 1:2

Date
2024.06

Page
7



ED98T - 12

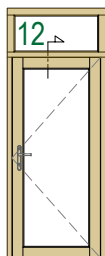
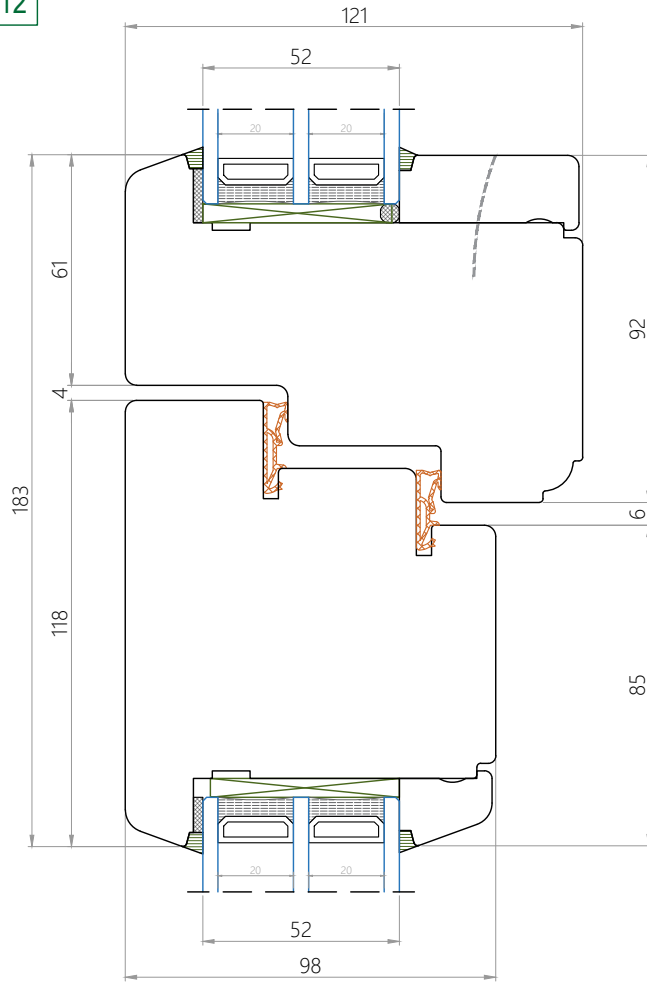

Product
ED98T
TIMBER OUTWARD
OPENING DOOR

Drawing Title
TRANSOM
SECTIONS

Glazing Unit
Triple Glazed

Scale A4 - 1:2	Date 2024.06	Page 8
-------------------	-----------------	-----------



ED98T - 13

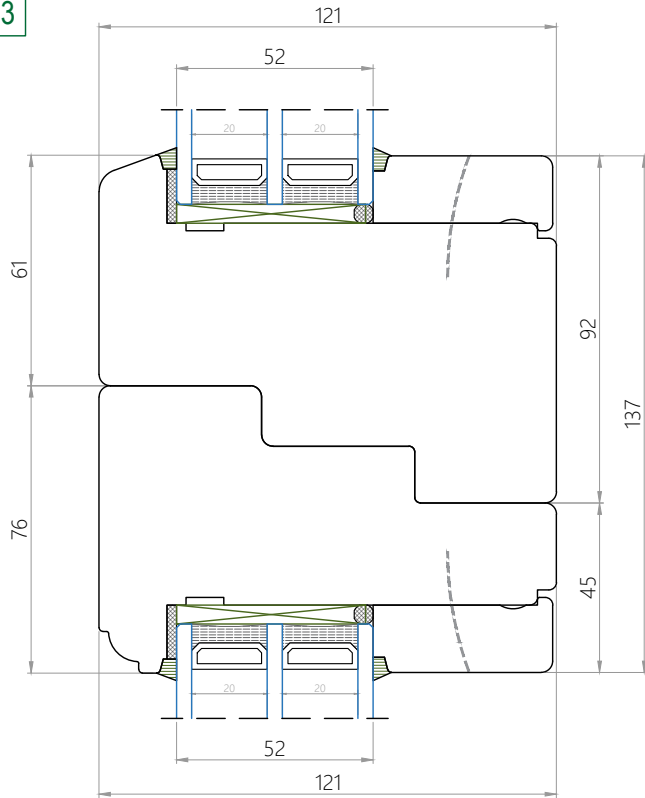

ED98T - 14

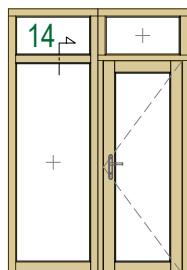
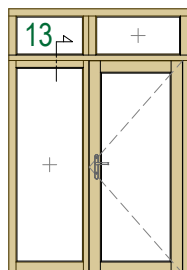
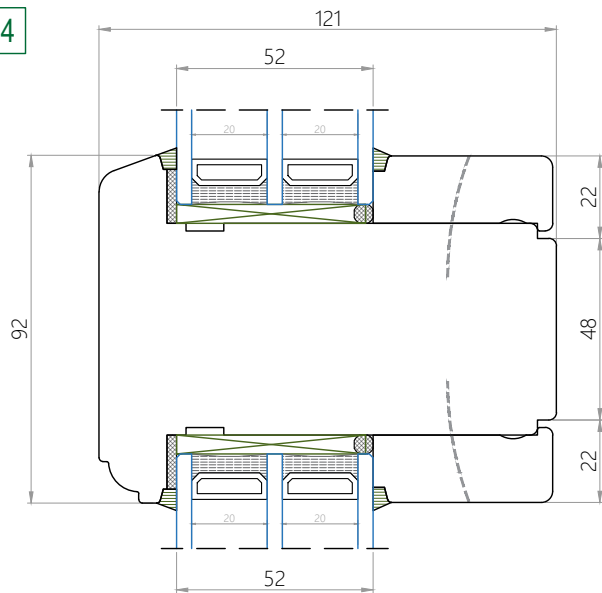

Product
ED98T
TIMBER OUTWARD
OPENING DOOR

Drawing Title
TRANSOM
SECTIONS

Glazing Unit
Triple Glazed

Scale A4 - 1:2	Date 2024.06	Page 9
-------------------	-----------------	-----------



ED98T - 15

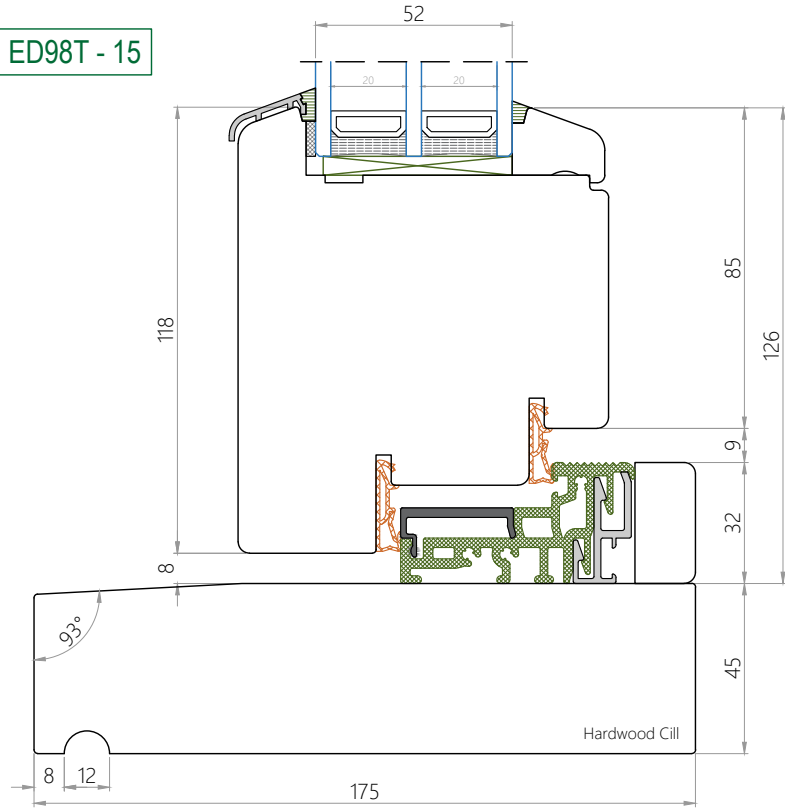

ED98T - 16

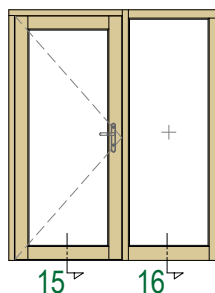
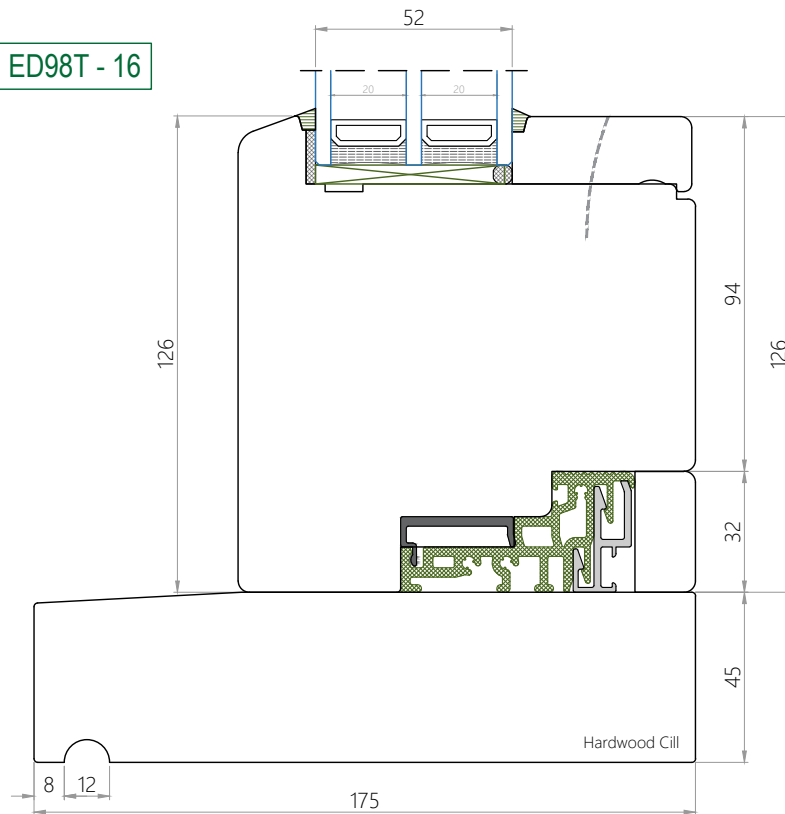

Product
ED98T
TIMBER OUTWARD
OPENING DOOR

Drawing Title
GLAZING BAR &
SOLID SASH BARS
OPTIONS

Glazing Unit
Triple Glazed

Scale A4 - 1:2	Date 2024.06	Page 10
-------------------	-----------------	------------



GLAZING BARS

ED98T - 17

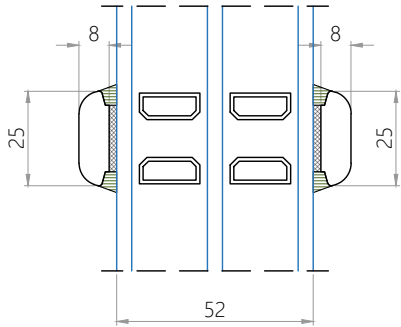

ED98T - 18

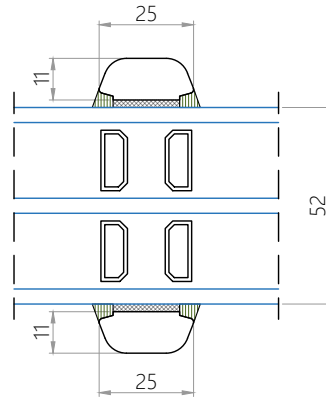

SOLID SASH BARS

ED98T - 19

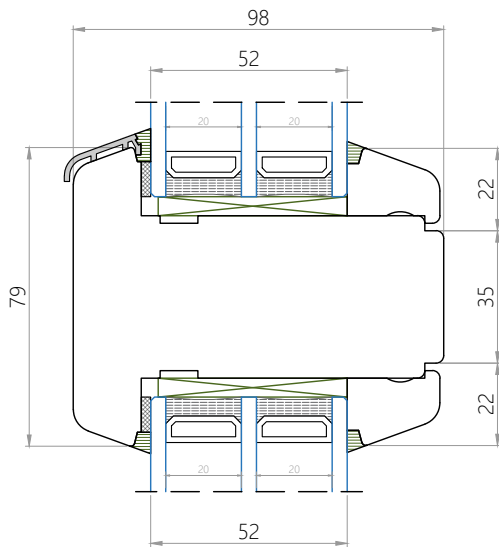

ED98T - 20

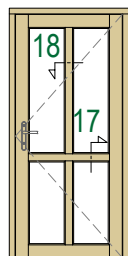
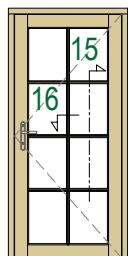
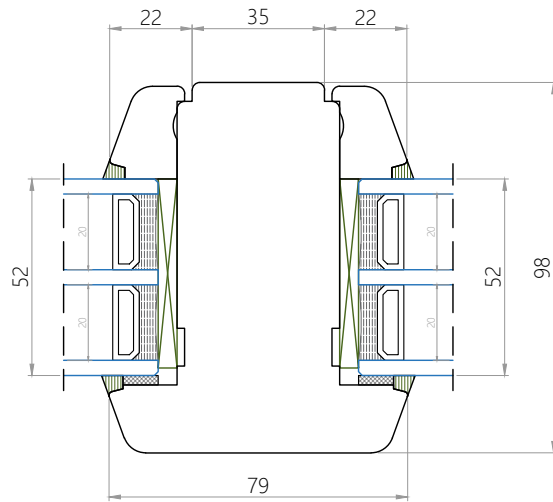

Product
ED98T
TIMBER OUTWARD
OPENING DOOR

Drawing Title
GLAZING BAR &
SOLID SASH BARS
OPTIONS

Glazing Unit
Triple Glazed

Scale A4 - 1:2	Date 2024.06	Page 11
-------------------	-----------------	------------

